

DINING TABLES

valid from 01.03.2022

GW-Export UK



GWINNER
S - DESIGN

Product and quality information

Why purchase one of our dining tables?

- // Our furniture ensures you can be the perfect host, yet still live comfortably.
- // Manufactured in Germany.
- // Quality begins by choosing the right materials. For that reason, Gwinner has been a member of the **Gütegemeinschaft Deutsche Möbel e.V.** (German Furniture Quality Association) for years – strict quality conditions, applicable DIN standards and safety regulations all go without saying. DGM's prestigious "Golden M" accolade is only awarded to furniture that has been tested in terms of safety and home hygiene. Ongoing quality checks ensure that every piece meets the home-hygiene requirements set by the German Federal Health Authority.
- // To protect the environment, we only use wood from managed and controlled sources. Our specialists carefully process the solid woods and real-wood veneers used, drawing on their expertise and craftsmanship. Particular characteristics, such as structural differences and natural knots in the veneers and solid woods, highlight the natural character of this material.
- // Our matt silk lacquered surfaces are manufactured using state-of-the-art, environmentally friendly technology. These surfaces are hard-wearing and meet the requirements for a healthy home environment. To prolong the life of these high-quality surfaces, avoid placing sharp-edged, hot or damp objects on them.
- // Please note that every piece of veneer and solid wood used is unique and can vary widely from one tree to another. Despite our specialists taking the greatest care, variations from brochure illustrations and display goods cannot be ruled out. For the oak timber, wild core beech and knotty walnut finishes in particular, veneers with cracks and knots are purposely chosen and filled to be darker. Only this time-consuming process gives the dining tables their desired natural character. We would like to expressly state that these growth and processing characteristics, as well as colour and texture differences, are desired features on our dining tables and they increase the value by being unique, and cannot therefore be seen as a quality defect.
- // subject to errors, as well as design, colour and material modifications as part of technical progress.

Available finishes and planning information

The materials and designs of the available tables have been created to match the latest Gwinner living room collection.

The lacquers, veneers and solid woods used match the colours seen across Gwinner living room furniture, coffee tables and chairs.

Please note the different designs available in the different series descriptions as not every table is available in every design.

For tables with a metal base, the base is available in stainless steel or powder-coated black at no extra cost. Please specify the required finish when ordering.

The dining table collection can be configured using the Furnplan planning programme:

furnplan

Gwinner dining tables have been awarded the DGM mark of quality by the German Furniture Quality Association

Country of manufacture: Germany

Home hygiene:

Gwinner dining tables meet the requirements for a healthy home environment, and have been tested for harmful substances in accordance with RAL-GZ 430/1-1.

Care instructions:

Wipe with a dry duster or a slightly damp cloth. The lacquers used are highly resistant to abrasion.



Customer services:

Sales:





You can call us:
Mon to Fri 8 a.m. – 5 p.m. Tel. +49 (0)7445 183 0



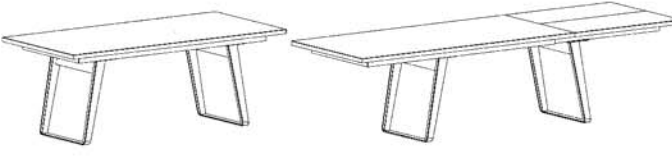

Planning information:

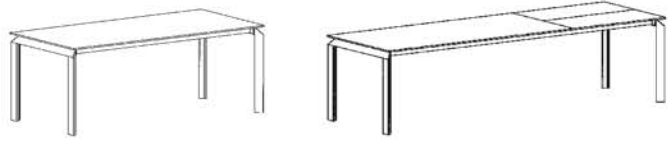
You can call us:
Mon to Fri 8 a.m. – 5 p.m. Tel. +49 (0)7445 183 370
Fax +49 (0)7445 183 399

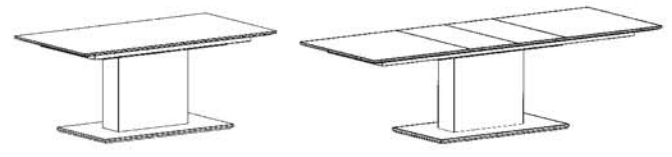
Website:

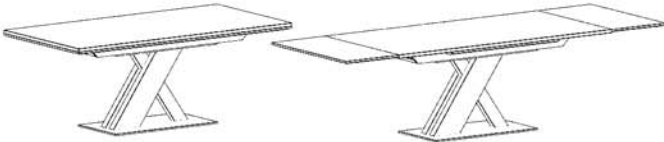
www.gwinner.de

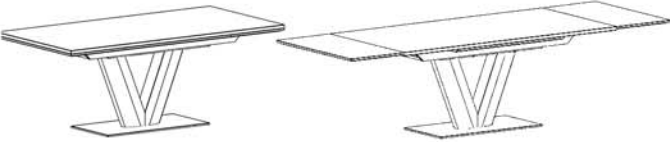
Range	Characteristic features
<p>ET580</p> 	<p>Dining table with four legs</p> <p>Function: Fixed or with sliding tabletop extension</p> <p>Tabletop: Real-wood veneer, lacquered, highly resistant to abrasion</p> <p>Extensions: Real-wood veneer, lacquered, highly resistant to abrasion</p> <p>Base: Oak or matt silk lacquer</p> <p>For available sizes and finishes, see page 7</p>
<p>ET570</p> 	<p>Dining table with base on runners</p> <p>Function: Fixed or with sliding tabletop extension</p> <p>Tabletop: Real-wood veneer, lacquered, highly resistant to abrasion</p> <p>Extensions: Real-wood veneer, lacquered, highly resistant to abrasion</p> <p>Base: Black or stainless steel finish with contrast cladding</p> <p>For available sizes and finishes, see page 8-9</p>
<p>ET581</p> 	<p>Dining table with four legs</p> <p>Function: Fixed or with sliding tabletop extension</p> <p>Tabletop: Real-wood veneer, lacquered, highly resistant to abrasion</p> <p>Extensions: Real-wood veneer, lacquered, highly resistant to abrasion</p> <p>Base: Black or stainless steel finish</p> <p>For available sizes and finishes, see page 10-11</p>
<p>ET521</p> 	<p>Dining table with four legs</p> <p>Function: Fixed or with pull-out extension</p> <p>Tabletop: Real-wood veneer or lacquered, highly resistant to abrasion</p> <p>Extensions: As tabletop or alternatively in Piton P.631 black, rust-effect look, nero marble effect</p> <p>Base: Black or stainless steel finish</p> <p>For available sizes and finishes, see page 12-13</p>
<p>ET524</p> 	<p>Dining table with four legs</p> <p>Function: Fixed or with pull-out extension</p> <p>Tabletop: Real-wood veneer, lacquered, highly resistant to abrasion</p> <p>Extensions: Real-wood veneer, lacquered, highly resistant to abrasion</p> <p>Base: Black or stainless steel finish</p> <p>For available sizes and finishes, see page 14-15</p>
<p>ET591</p> 	<p>Dining table with pedestal leg</p> <p>Function: Fixed or extending with extension panels</p> <p>Tabletop: Rectangular, real-wood veneer, lacquered, highly resistant to abrasion</p> <p>Extension panels: Matt silk lacquer</p> <p>Base: Matt silk lacquer</p> <p>Base plate: Black or stainless steel finish</p> <p>For available sizes and finishes, see page 16-17</p>

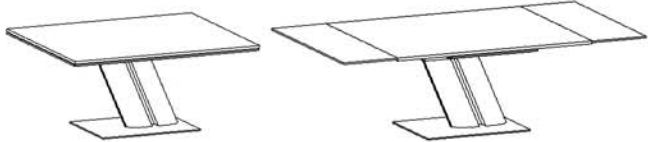
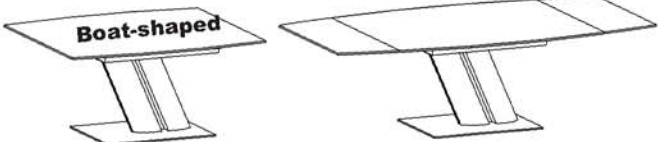
Range	Characteristic features
<p>ET612</p> 	<p>Dining table with X-shaped base Function: Fixed or with lift extension Tabletop: Rectangular, real-wood veneer, lacquered, highly resistant to abrasion Extensions: Real-wood veneer, lacquered, highly resistant to abrasion Base: Lacquer or real-wood veneer Base plate and metal supports: Black or stainless steel finish For available sizes and finishes, see page 18-19</p>
<p>ET613</p> 	<p>Dining table with X-shaped base Function: Fixed or with lift extension Tabletop: Boat-shaped, real-wood veneer, lacquered, highly resistant to abrasion Extensions: Real-wood veneer, lacquered, highly resistant to abrasion Base: Lacquer or real-wood veneer Base plate and metal supports: Black or stainless steel finish For available sizes and finishes, see page 20-21</p>
<p>ET632</p> 	<p>Dining table with V-shaped base Function: Fixed or with lift extension Tabletop: Rectangular, real-wood veneer, lacquered, highly resistant to abrasion Extensions: Real-wood veneer, lacquered, highly resistant to abrasion Base: Lacquer or real-wood veneer Base plate: Black or stainless steel finish For available sizes and finishes, see page 22-23</p>
<p>ET633</p> 	<p>Dining table with V-shaped base Function: Fixed or with lift extension Tabletop: Boat-shaped, real-wood veneer, lacquered, highly resistant to abrasion Extensions: Real-wood veneer, lacquered, highly resistant to abrasion Base: Lacquer or real-wood veneer Base plate: Black or stainless steel finish For available sizes and finishes, see page 24-25</p>
<p>ET642 NEW</p> 	<p>Dining table with double pedestal leg Function: Fixed or with lift extension Tabletop: Rectangular, real-wood veneer, lacquered, highly resistant to abrasion Extensions: Real-wood veneer, lacquered, highly resistant to abrasion Base: Lacquer or real-wood veneer Base plate: Black or stainless steel finish For available sizes and finishes, see page 26-27</p>
<p>ET643 NEW</p> 	<p>Dining table with double pedestal leg Function: Fixed or with lift extension Tabletop: Boat-shaped, real-wood veneer, lacquered, highly resistant to abrasion Extensions: Real-wood veneer, lacquered, highly resistant to abrasion Base: Lacquer or real-wood veneer Base plate: Black or stainless steel finish For available sizes and finishes, see page 28-29</p>

Dining table collection overview: Functional tables & tables with fixed tops

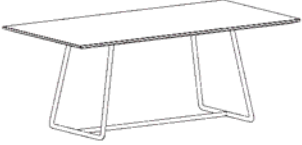
Range	Characteristic features
<p>ET811</p> 	<p>Dining table with pedestal leg Function: Fixed or with synchronous extension and folding insert Tabletop: Round, real-wood veneer, lacquered, highly resistant to abrasion Extensions: Real-wood veneer, lacquered, highly resistant to abrasion Base: Lacquer or real-wood veneer Base plate: Black or stainless steel finish For available sizes and finishes, see page 30</p>
<p>ET871</p> 	<p>Dining table with bracket frame Function: Fixed Tabletop: Rectangular, real-wood veneer, lacquered, highly resistant to abrasion Base: Anthracite For available sizes and finishes, see page 31</p>

Price group 2
Finishes for the base: Natural oak, honey oak. White, cream, cashmere, fango, taupe, anthracite matt silk lacquer.
Tabletop veneer finishes: Natural wild core beech, honey wild oak, honey oak timber, natural oak timber, planked natural walnut (without sapwood), natural knotty walnut.

ET580 Dining table with four legs, rectangular tabletop, height 76 cm

- Function:** Fixed or extending with sliding tabletop extension at a surcharge.
- Tabletop:** Real-wood veneer, lacquered, highly resistant to abrasion, longitudinal veneer direction.
- Extensions:** Real-wood veneer, lacquered, highly resistant to abrasion, continuous veneer along the tabletop and extensions.
- Base:** Natural oak, honey oak or matt silk lacquer.

Standard design shown, without extension

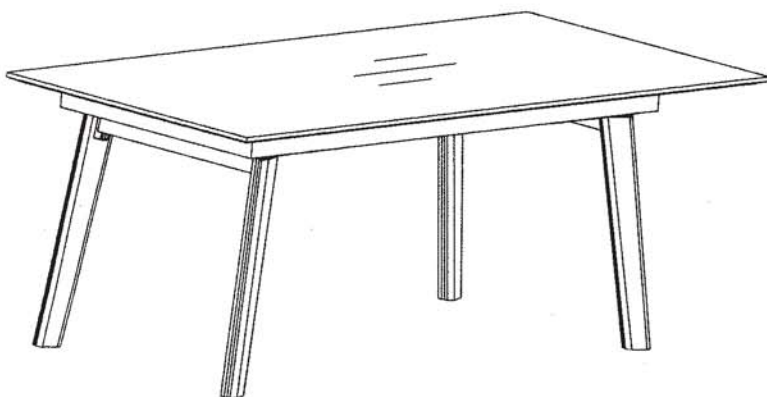

Tabletop cross-section, **MDF 2.3 cm thick**

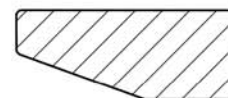

Sizes	Length: 160 cm	Length: 180 cm	Length: 200 cm
	Width: 95 cm	Width: 95 cm	Width: 95 cm
Order no. PG 2	ET580-160	ET580-180	ET580-200

Surcharge for sliding tabletop extension Shown with sliding tabletop extension



Order no. PG 2	For ET580-160 One side 80 cm	For ET580-180 One side 100 cm	For ET580-200 One side 100 cm
	SA580-160	SA580-180	SA580-200

Price group 2**Runners in black or stainless steel finish.**

Contrasting surface: Natural wild core beech, honey oak timber, honey wild oak, natural wild oak, natural oak timber, satin natural oak, natural walnut, natural knotty walnut.

Tabletop veneer finishes:

Natural wild core beech, honey wild oak, natural wild oak, honey oak timber, natural oak timber, satin natural oak, planked natural walnut (without sapwood), natural knotty walnut.

Price group 3**Runners in black or stainless steel finish.**

Contrasting surface: Textured terra oak timber.

Tabletop veneer finishes:

Textured terra oak timber.

ET570 Dining table with base on runners, rectangular tabletop, height 76 cm

- Function:** Fixed or extending with sliding tabletop extension at a surcharge.
- Tabletop:** Real-wood veneer, lacquered, highly resistant to abrasion, longitudinal veneer direction.
- Extensions:** Real-wood veneer, lacquered, highly resistant to abrasion, continuous veneer along the tabletop and extensions.
- Base:** Powder-coated black or stainless steel finish.
- Contrasting surface:** Solid wood that matches the tabletop.

Standard design shown, without extension

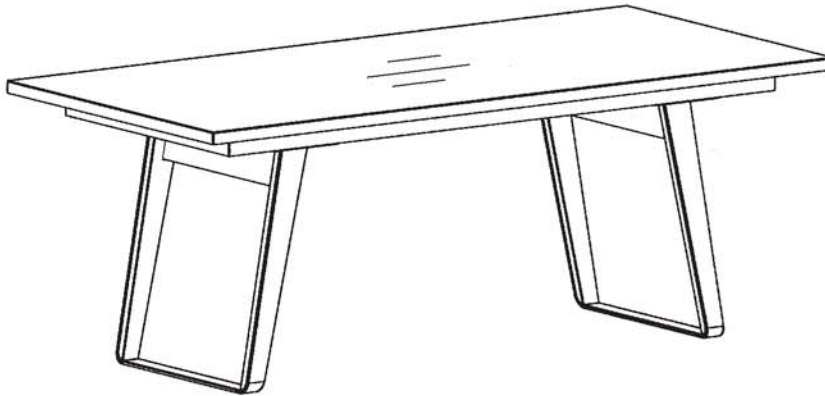

Tabletop cross-section,
MDF 2.3 cm thick

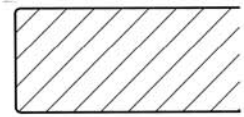

Sizes

Length: 160 cm
Width: 95 cm

Length: 180 cm
Width: 95 cm

Length: 200 cm
Width: 95 cm

Order no.
PG 2
PG 3

ET570-160

ET570-180

ET570-200

Shown with sliding tabletop extension

Surcharge for sliding tabletop extension



For ET570-160
One side 80 cm

For ET570-180
One side 100 cm

For ET570-200
One side 100 cm

Order no.
PG 2
PG 3

SA570-160

SA570-180

SA570-200

Price group 2

Base in black or stainless steel finish.

Tabletop veneer finishes:

Natural wild core beech, honey wild oak, natural wild oak, honey oak timber, natural oak timber, satin natural oak, planked natural walnut (without sapwood), natural knotty walnut.

Price group 3

Base in black or stainless steel finish.

Tabletop veneer finishes:

Textured terra oak timber.

ET581 Dining table with four legs, rectangular tabletop, height 76 cm

- Function:** Fixed or extending with sliding tabletop extension at a surcharge.
- Tabletop:** Real-wood veneer, lacquered, highly resistant to abrasion, longitudinal veneer direction.
- Extensions:** Real-wood veneer, lacquered, highly resistant to abrasion, continuous veneer along the tabletop and extensions.
- Base:** Powder-coated black or stainless steel finish.

Standard design shown, without extension

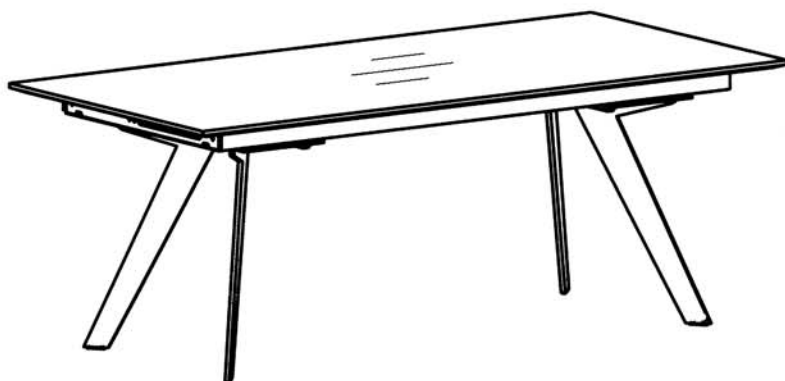

Tabletop cross-section,
MDF 2.3 cm thick

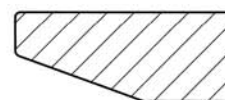

Sizes

Length: 160 cm
Width: 95 cm

Length: 180 cm
Width: 95 cm

Length: 200 cm
Width: 95 cm

Order no.
PG 2
PG 3

ET581-160

ET581-180

ET581-200

Planning information: The sliding tabletop extension is only available on tables up to 200 cm long.

Sizes

Length: 220 cm
Width: 100 cm

Length: 240 cm
Width: 100 cm

Length: 260 cm
Width: 100 cm

Order no.
PG 2
PG 3

ET581-220

ET581-240

ET581-260

Shown with sliding tabletop extension

Surcharge for sliding tabletop extension



For ET581-160
One side 80 cm

For ET581-180
One side 100 cm

For ET581-200
One side 100 cm

Order no.
PG 2
PG 3

SA581-160

SA581-180

SA581-200

Price group 1

Base in black or stainless steel finish.

Contrasting surface in the base: White, cream, fango, black matt silk lacquer.

Tabletop and pull-out extension matt silk lacquer finishes:

White, cream, fango.

Additional finishes only available for the pull-out extension:

rust-effect or concrete look laminate.

Price group 2

Base in black or stainless steel finish.

Contrasting surface in the base: Honey oak timber, honey wild oak, natural wild oak, natural oak timber, satin natural oak, natural walnut, natural knotty walnut.
White, cream, fango, taupe, cashmere, anthracite, black matt silk lacquer.

Tabletop and pull-out extension veneer finishes:

Honey wild oak, honey oak timber, natural wild oak, natural oak timber, satin natural oak, planked natural walnut (without sapwood), natural knotty walnut.

Additional finishes only available for the pull-out extension:

Rust-effect or concrete look laminate.

Price group 3

Base in black or stainless steel finish. Contrasting surface in the base:

Textured terra oak timber.

White, cream, fango, taupe, cashmere, anthracite, black matt silk lacquer.

Tabletop and pull-out extension veneer finishes:

Textured terra oak timber.

ET521 Dining table with four legs, rectangular tabletop, height 76 cm

- Function:** Fixed or extending with pull-out extension at a surcharge.
- Tabletop:** Real-wood veneer, lacquered, highly resistant to abrasion, longitudinal veneer direction or matt silk lacquer.
- Extensions:** Real-wood veneer, lacquered, highly resistant to abrasion, continuous veneer along the tabletop and pull-out extension.
Alternatively in matt silk lacquer, laminate, Piton P.631 black.
- Base:** Powder-coated black or stainless steel finish.
- Contrasting surface in the base:** Real-wood veneer or matt silk lacquer.

Standard design shown, without extension

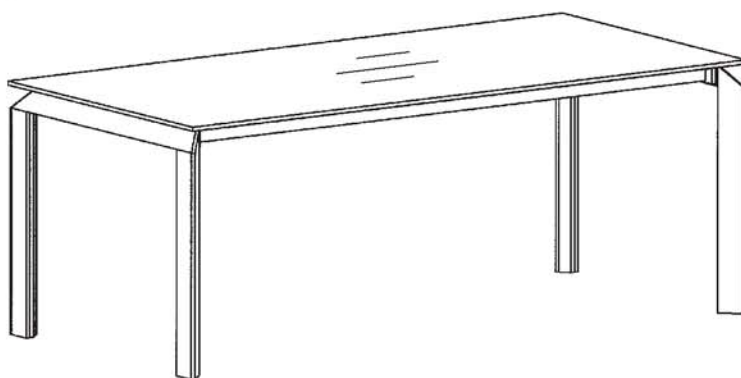

Tabletop cross-section,
MDF 1.9 cm thick

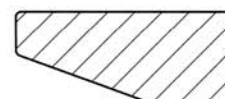

Sizes	Length: 160 cm Width: 95 cm	Length: 180 cm Width: 95 cm	Length: 200 cm Width: 95 cm
Order no.	ET521-160	ET521-180	ET521-200
PG 1			
PG 2			
PG 3			

Surcharge for pull-out extension

Shown with pull-out extension

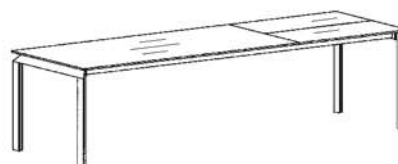

Order no.	For ET521-160 One side 80 cm KA521-160	For ET521-180 One side 100 cm KA521-180	For ET521-200 One side 100 cm KA521-200
PG 1			
PG 2			
PG 3			

Price group 2

Base in black or stainless steel finish.

Tabletop veneer finishes:

Natural wild core beech, honey wild oak, natural wild oak, honey oak timber, natural oak timber, satin natural oak, planked natural walnut (without sapwood), natural knotty walnut.

Price group 3

Base in black or stainless steel finish.

Tabletop veneer finishes:

Textured terra oak timber.

ET524 Dining table with four legs, rectangular tabletop, height 76 cm

- Function:** Fixed or extending with pull-out extension at a surcharge.
- Tabletop:** Real-wood veneer, lacquered, highly resistant to abrasion, longitudinal veneer direction.
- Extensions:** Real-wood veneer, lacquered, highly resistant to abrasion, continuous veneer along the tabletop and extensions.
- Base:** Powder-coated black or stainless steel finish.

Standard design shown, without extension

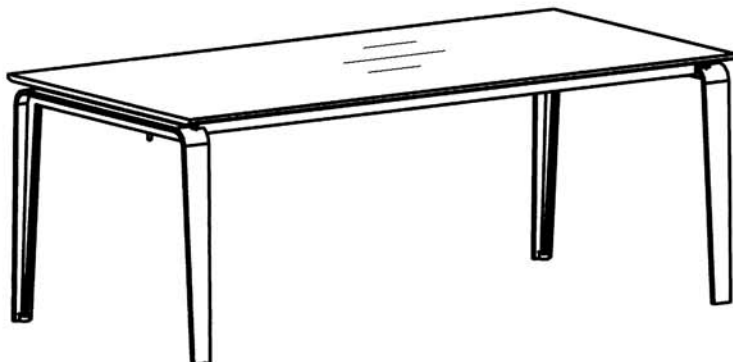

Tabletop cross-section,
MDF 1.9 cm thick

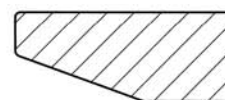

Sizes

Length: 160 cm
Width: 95 cm

Length: 180 cm
Width: 95 cm

Length: 200 cm
Width: 95 cm

Order no.
PG 2
PG 3

ET524-160

ET524-180

ET524-200

Surcharge for pull-out extension

Shown with pull-out extension

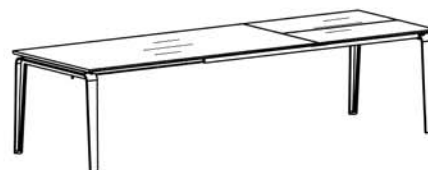

For ET524-160
One side 80 cm

For ET524-180
One side 100 cm

For ET524-200
One side 100 cm

Order no.
PG 2
PG 3

KA524-160

KA524-180

KA524-200

Price group 2**Lacquer finishes for the base:**

white, cream, cashmere, fango, taupe, anthracite matt silk lacquer.

Tabletop veneer finishes:

Natural wild core beech, honey wild oak, honey oak timber, natural oak timber, planked natural walnut (without sapwood), natural knotty walnut.

ET591 Dining table with pedestal leg, rectangular tabletop, height 76 cm

- Function:** Fixed or extending with extension panels at a surcharge.
- Tabletop:** Real-wood veneer, lacquered, highly resistant to abrasion, longitudinal veneer direction.
- Extension panels:** Matt silk lacquer.
- Base:** Matt silk lacquer.
- Base plate:** Powder-coated black or stainless steel finish.

Standard design shown, without extension panels

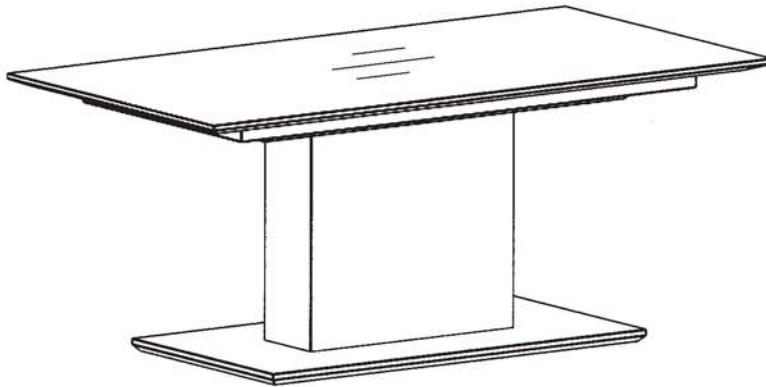

Tabletop cross-section,
MDF 2.3 cm thick

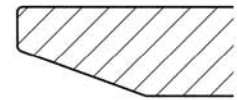

Sizes

Length: 160 cm
Width: 95 cm

Length: 180 cm
Width: 95 cm

Order no.
PG 2

ET591-160

ET591-180

Surcharge for synchronous extension with extension panels

Shown with one extension panel

Planning information: The extension is two-fold, with one or two extension panels, each measuring 45 cm. The table is extended in both directions at the same time. The extension panels are stored within the table. For construction reasons, the **ET591-160** cannot be extended.

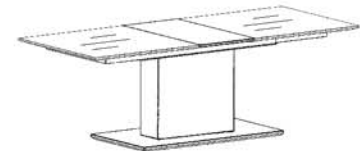

For ET591-180
2 X 45 cm

Shown with both extension panels

Order no.
PG 2

SE591-180

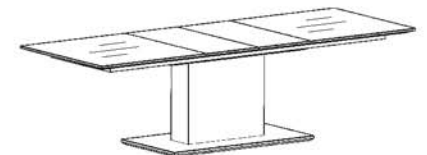

Price group 2**Lacquer or veneer finishes for the base:**

White, cream, cashmere, fango, taupe, anthracite matt silk lacquer. Natural wild core beech, honey wild oak, honey oak timber, natural oak timber, satin natural oak, planked natural walnut (without sapwood), natural knotty walnut.

Tabletop veneer finishes:

Natural wild core beech, honey wild oak, natural wild oak, honey oak timber, natural oak timber, satin natural oak, planked natural walnut (without sapwood), natural knotty walnut.

ET612 Dining table with X-shaped base, rectangular tabletop, height 76 cm

- Function:** Fixed or extending with lift extension at a surcharge.
- Tabletop:** Real-wood veneer, lacquered, highly resistant to abrasion, longitudinal veneer direction.
- Extensions:** Real-wood veneer, lacquered, highly resistant to abrasion, continuous longitudinal veneer direction.
- Base:** Matt silk lacquer or real-wood veneer, powder-coated black or stainless steel metal supports.
- Base plate:** Powder-coated black or stainless steel finish.

Standard design shown, without extensions

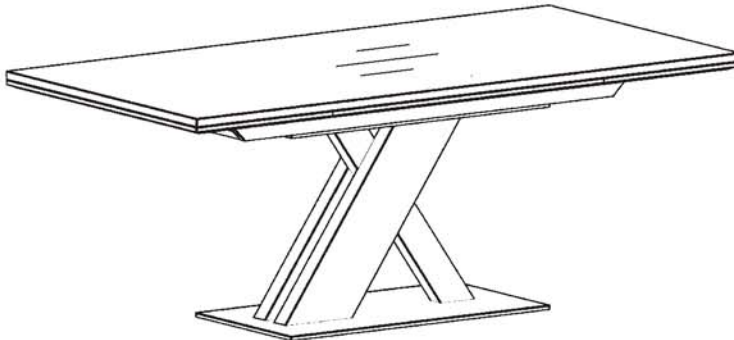

Tabletop cross-section,
MDF 2 x 2.3 cm thick

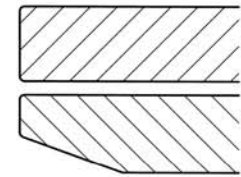

Sizes

Length: 140 cm
Width: 90 cm

Length: 160 cm
Width: 90 cm

Length: 180 cm
Width: 100 cm

Length: 200 cm
Width: 100 cm

Order no.
PG 2

ET612-140

ET612-160

ET612-180

ET612-200

Surcharge for lift extension on both sides

Planning information:

It is not possible to include a lift extension on both sides on the **ET612-140**.

Shown with lift extension on both sides



Order no.
PG 2

For ET612-160
Both sides 45 cm each
LAB612-160

For ET612-180
Both sides 50 cm each
LAB612-180

For ET612-200
Both sides 50 cm each
LAB612-200

Surcharge for lift extension on one side

Shown with lift extension on one side



Order no.
PG 2

For ET612-140
One side 50 cm
LA612-140

For ET612-160
One side 50 cm
LA612-160

For ET612-180
One side 50 cm
LA612-180

For ET612-200
One side 50 cm
LA612-200

Price group 2**Lacquer or veneer finishes for the base:**

White, cream, cashmere, fango, taupe, anthracite matt silk lacquer.

Natural wild core beech, honey wild oak, honey oak timber, natural oak timber, satin natural oak, planked natural walnut (without sapwood), natural knotty walnut.

Tabletop veneer finishes:

Natural wild core beech, honey wild oak, natural wild oak, honey oak timber, natural oak timber, satin natural oak, planked natural walnut (without sapwood), natural knotty walnut.

ET613 Dining table with X-shaped base, boat-shaped tabletop, height 76 cm

- Function:** Fixed or extending with lift extension at a surcharge.
- Tabletop:** Real-wood veneer, lacquered, highly resistant to abrasion, longitudinal veneer direction.
- Extensions:** Real-wood veneer, lacquered, highly resistant to abrasion, continuous longitudinal veneer direction.
- Base:** Matt silk lacquer or real-wood veneer, powder-coated black or stainless steel metal supports.
- Base plate:** Powder-coated black or stainless steel finish.

Standard design shown, without extensions

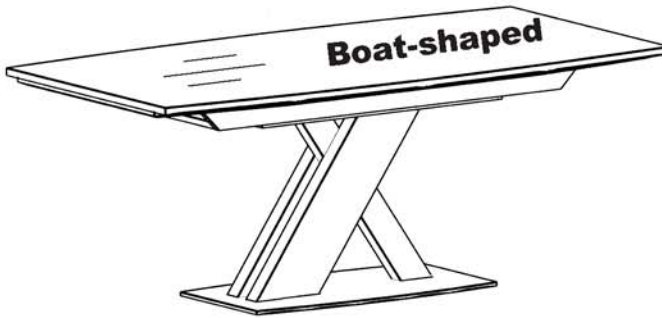

Tabletop cross-section,
MDF 2.3 cm thick

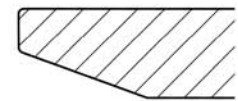

Sizes

Length: 160 cm	Length: 180 cm	Length: 200 cm
Width: 100 cm	Width: 100 cm	Width: 100 cm

Order no.
PG 2

ET613-160

ET613-180

ET613-200

Surcharge for lift extension on both sides

Shown with lift extension on both sides

For ET613-160 Both sides 45 cm each	For ET613-180 Both sides 50 cm each	For ET613-200 Both sides 50 cm each
LAB613-160	LAB613-180	LAB613-200

Order no.
PG 2



Surcharge for lift extension on one side

Shown with lift extension on one side

For ET613-160 One side 50 cm	For ET613-180 One side 50 cm	For ET613-200 One side 50 cm
LA613-160	LA613-180	LA613-200

Order no.
PG 2



Price group 2**Lacquer or veneer finishes for the base:**

White, cream, cashmere, fango, taupe, anthracite matt silk lacquer.

Natural wild core beech, honey wild oak, honey oak timber, natural oak timber, satin natural oak, planked natural walnut (without sapwood), natural knotty walnut.

Tabletop veneer finishes:

Natural wild core beech, honey wild oak, honey oak timber, natural oak timber, planked natural walnut (without sapwood), natural knotty walnut.

When choosing the satin natural oak finish, the base is made from natural wild oak.

ET632 Dining table with V-shaped base, rectangular tabletop, height 76 cm

- Function:** Fixed or extending with lift extension at a surcharge.
- Tabletop:** Real-wood veneer, lacquered, highly resistant to abrasion, longitudinal veneer direction.
- Extensions:** Real-wood veneer, lacquered, highly resistant to abrasion, continuous longitudinal veneer direction.
- Base:** Matt silk lacquer or real-wood veneer.
- Base plate:** Powder-coated black or stainless steel finish.

Standard design shown, without extensions

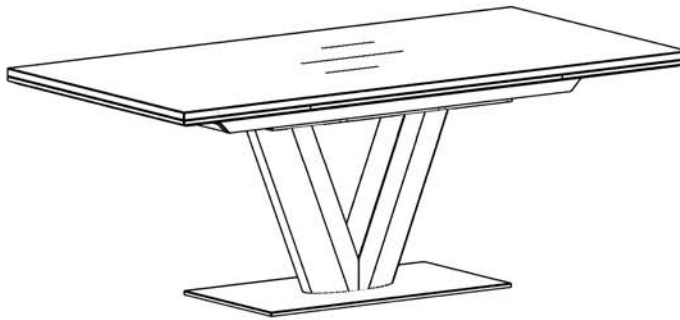

Tabletop cross-section,
MDF 2 x 2.3 cm thick

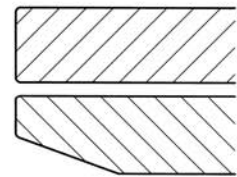

Sizes

Length: 140 cm Width: 90 cm	Length: 160 cm Width: 90 cm	Length: 180 cm Width: 100 cm	Length: 200 cm Width: 100 cm
--	--	---	---

Order no.
PG 2

ET632-140

ET632-160

ET632-180

ET632-200

Surcharge for lift extension on both sides

Planning information:

It is not possible to include a lift extension on both sides on the **ET632-140**.

Shown with lift extension on both sides



Order no.
PG 2

For ET632-160
Both sides 45 cm each
LAB632-160

For ET632-180
Both sides 50 cm each
LAB632-180

For ET632-200
Both sides 50 cm each
LAB632-200

Surcharge for lift extension on one side

Shown with lift extension on one side



Order no.
PG 2

For ET632-140
One side 50 cm
LA632-140

For ET632-160
One side 50 cm
LA632-160

For ET632-180
One side 50 cm
LA632-180

For ET632-200
One side 50 cm
LA632-200

Price group 2**Lacquer or veneer finishes for the base:**

White, cream, cashmere, fango, taupe, anthracite matt silk lacquer.

Natural wild core beech, honey wild oak, honey oak timber, natural oak timber, satin natural oak, planked natural walnut (without sapwood), natural knotty walnut.

Tabletop veneer finishes:

Natural wild core beech, honey wild oak, honey oak timber, natural oak timber, planked natural walnut (without sapwood), natural knotty walnut.

When choosing the satin natural oak finish, the base is made from natural wild oak.

ET633 Dining table with V-shaped base, boat-shaped tabletop, height 76 cm

- Function:** Fixed or extending with lift extension at a surcharge
- Tabletop:** Real-wood veneer, lacquered, highly resistant to abrasion, longitudinal veneer direction.
- Extensions:** Real-wood veneer, lacquered, highly resistant to abrasion, continuous longitudinal veneer direction.
- Base:** Matt silk lacquer or real-wood veneer.
- Base plate:** Powder-coated black or stainless steel finish.

Standard design shown, without extensions

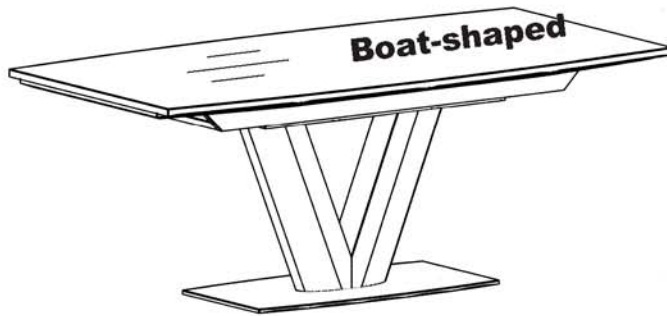

Tabletop cross-section,
MDF 2.3 cm thick

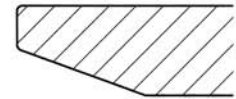

Sizes	Length: 160 cm	Length: 180 cm	Length: 200 cm
	Width: 100 cm	Width: 100 cm	Width: 100 cm
Order no. PG 2	ET633-160	ET633-180	ET633-200

Surcharge for lift extension on both sides

Shown with lift extension on both sides

Order no. PG 2	For ET633-160 Both sides 45 cm each	For ET633-180 Both sides 50 cm each	For ET633-200 Both sides 50 cm each
	LAB633-160	LAB633-180	LAB633-200



Surcharge for lift extension on one side

Shown with lift extension on one side

Order no. PG 2	For ET633-160 One side 50 cm	For ET633-180 One side 50 cm	For ET633-200 One side 50 cm
	LA633-160	LA633-180	LA633-200

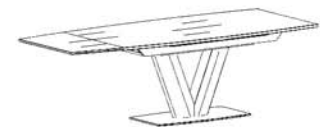

Price group 2**Lacquer or veneer finishes for the base:**

White, cream, cashmere, fango, taupe, anthracite matt silk lacquer.

Natural wild core beech, honey wild oak, honey oak timber, natural oak timber, satin natural oak, planked natural walnut (without sapwood), natural knotty walnut.

Tabletop veneer finishes:

Natural wild core beech, honey wild oak, honey oak timber, natural oak timber, planked natural walnut (without sapwood), natural knotty walnut.

When choosing the satin natural oak finish, the base is made from natural wild oak.

ET642 Dining table with double pedestal leg, rectangular tabletop, height 76 cm

- Function:** Fixed or extending with lift extension at a surcharge.
- Tabletop:** Real-wood veneer, lacquered, highly resistant to abrasion, longitudinal veneer direction.
- Extensions:** Real-wood veneer, lacquered, highly resistant to abrasion, continuous longitudinal veneer direction.
- Base:** Matt silk lacquer or real-wood veneer.
- Base plate:** Powder-coated black or stainless steel finish.

Standard design shown, without extensions

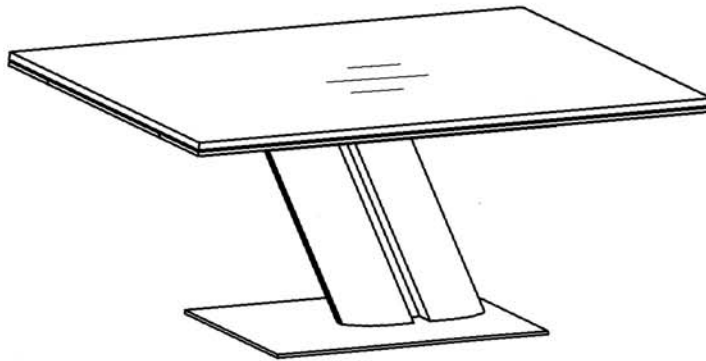

Tabletop cross-section,
MDF 2 x 2.3 cm thick

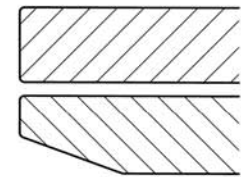

Sizes	Length: 140 cm Width: 90 cm	Length: 160 cm Width: 90 cm	Length: 180 cm Width: 100 cm	Length: 200 cm Width: 100 cm
Order no. PG 2	ET642-140	ET642-160	ET642-180	ET642-200

Surcharge for lift extension on both sides

Planning information:

It is not possible to include a lift extension on both sides on the **ET642-140**.

Shown with lift
extension on both
sides

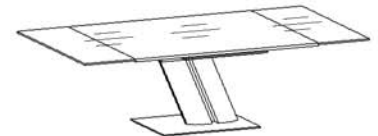

Order no. PG 2	For ET642-160 Both sides 45 cm each LAB642-160	For ET642-180 Both sides 50 cm each LAB642-180	For ET642-200 Both sides 50 cm each LAB642-200
-------------------	--	--	--

Surcharge for lift extension on one side

Shown with lift
extension on one
side



Order no. PG 2	For ET642-140 One side 50 cm LA642-140	For ET642-160 One side 50 cm LA642-160	For ET642-180 One side 50 cm LA642-180	For ET642-200 One side 50 cm LA642-200
-------------------	--	--	--	--

Price group 2**Lacquer or veneer finishes for the base:**

White, cream, cashmere, fango, taupe, anthracite matt silk lacquer.

Natural wild core beech, honey wild oak, honey oak timber, natural oak timber, satin natural oak, planked natural walnut (without sapwood), natural knotty walnut.

Tabletop veneer finishes:

Natural wild core beech, honey wild oak, honey oak timber, natural oak timber, planked natural walnut (without sapwood), natural knotty walnut.

When choosing the satin natural oak finish, the base is made from natural wild oak.

ET643 Dining table with double pedestal leg, rectangular tabletop, height 76 cm

- Function:** Fixed or extending with lift extension at a surcharge
- Tabletop:** Real-wood veneer, lacquered, highly resistant to abrasion, longitudinal veneer direction.
- Extensions:** Real-wood veneer, lacquered, highly resistant to abrasion, continuous longitudinal veneer direction.
- Base:** Matt silk lacquer or real-wood veneer.
- Base plate:** Powder-coated black or stainless steel finish.

Standard design shown, without extensions

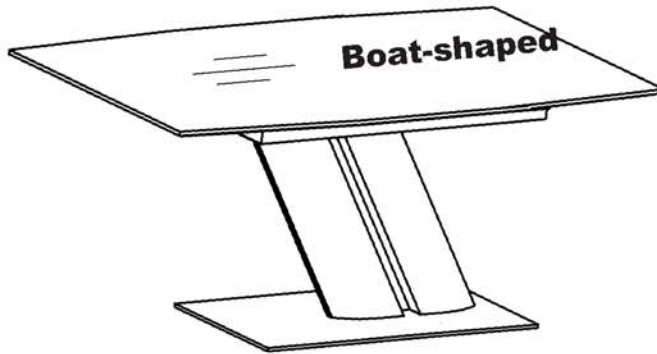

Tabletop cross-section,
MDF 2.3 cm thick

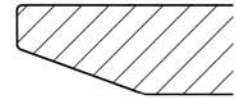

Sizes	Length: 160 cm	Length: 180 cm	Length: 200 cm
	Width: 100 cm	Width: 100 cm	Width: 100 cm
Order no.	ET643-160	ET643-180	ET643-200
PG 2			

Surcharge for lift extension on both sides

Shown with lift extension on both sides

Order no.	For ET643-160	For ET643-180	For ET643-200
	PG 2	Both sides 45 cm each LAB643-160	Both sides 50 cm each LAB643-180

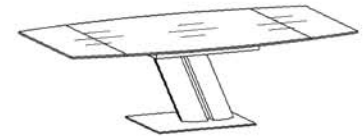

Surcharge for lift extension on one side

Shown with lift extension on one side

Order no.	For ET643-160	For ET643-180	For ET643-200
	PG 2	One side 50 cm LA643-160	One side 50 cm LA643-180

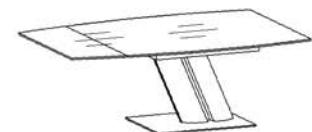

Price group 2

Lacquer or veneer finishes for the base:

White, cream, cashmere, fango, taupe, anthracite matt silk lacquer.
 Honey wild oak, honey oak timber, natural oak timber,
 planked natural walnut (without sapwood), natural knotty walnut.

Tabletop veneer finishes:

Honey wild oak, honey oak timber, natural oak timber,
 planked natural walnut (without sapwood), natural knotty walnut.

ET811 Round dining table with pedestal leg, height 76 cm

- Function:** Fixed or extending with synchronous extension and folding insert at a surcharge.
- Tabletop:** Real-wood veneer, lacquered, highly resistant to abrasion, lateral veneer.
- Folding insert:** Real-wood veneer, lacquered, highly resistant to abrasion, lateral veneer.
- Base:** Matt silk lacquer or veneer.
- Base plate:** Powder-coated black or stainless steel finish.

Standard design shown, without extension

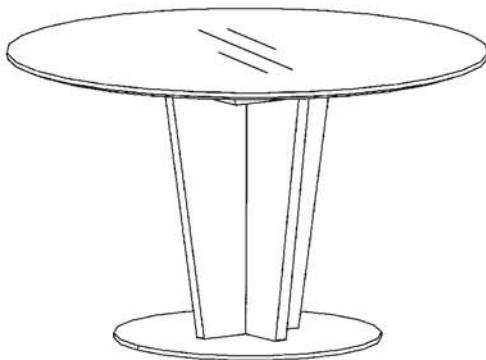

Tabletop cross-section,
MDF 2.3 cm thick

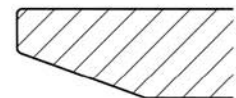

Sizes **Length:** 126 cm
 Width: 126 cm

Order no. **ET811-126**
 PG 2

Surcharge for synchronous extension with folding insert

Planning information: The extension opens in both directions at the same time; when retracted, the 50-cm-long folding insert is hidden inside the table construction.

Shown with folding insert



Order no. **SK811-126**
 PG 2

Price group 2**Base:** Powder-coated anthracite.**Tabletop veneer finishes:**

Natural oak timber.

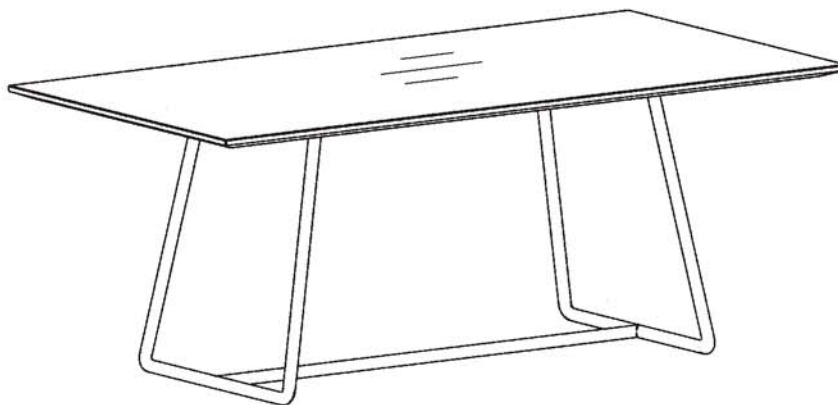
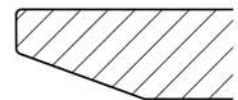
ET871 Dining table with bracket frame, rectangular tabletop, height 75 cm**Tabletop:** Real-wood veneer, lacquered, highly resistant to abrasion, longitudinal veneer direction.**Base:** Powder-coated anthracite.Tabletop cross-section,
MDF 2.3 cm thick**Sizes****Length:** 160 cm
Width: 90 cm**Length:** 180 cm
Width: 100 cm**Order no.**
PG 2

ET871-160

ET871-180

GWINNER
S - D E S I G N