

COFFEE TABLES

valid from 01.03.2022



GWINNER[®]

Product and quality information

Why purchase one of our coffee tables?

- // Our furniture ensures you can be the perfect host, yet still live comfortably.

- // Quality begins by choosing the right materials. For that reason, Gwinner has been a member of the **Gütegemeinschaft Deutsche Möbel e.V.** (German Furniture Quality Association) for years – strict quality conditions, applicable DIN standards and safety regulations all go without saying. DGM's prestigious "Golden M" accolade is only awarded to furniture that has been tested in terms of safety and home hygiene. Ongoing quality checks ensure that every piece meets the home-hygiene requirements set by the German Federal Health Authority.

- // To protect the environment, we only use wood from managed and controlled sources. Our specialists carefully process the solid woods and real-wood veneers used, drawing on their expertise and craftsmanship. Particular characteristics, such as structural differences and natural knots in the veneers and solid woods, highlight the natural character of this material.

- // Our matt silk lacquered surfaces are manufactured using state-of-the-art, environmentally friendly technology. These surfaces are hard-wearing and meet the requirements for a healthy home environment. To prolong the life of these high-quality surfaces, avoid placing sharp-edged, hot or damp objects on them.

- // The woods and lacquered specifically match the Gwinner living-room ranges.

- // Please note that every piece of veneer and solid wood used is unique and can vary widely from one tree to another. Despite our specialists taking the greatest care, variations from brochure illustrations and display goods cannot be ruled out. For the oak timber, wild core beech and knotty walnut finishes in particular, veneers with cracks and knots are purposely chosen and filled to be darker. Only this time-consuming process gives the coffee tables their desired natural character. We would like to expressly state that these growth and processing characteristics, as well as colour and texture differences, are desired features on our coffee tables and they increase the value by being unique, and cannot therefore be seen as a quality defect.

- // subject to errors, as well as design, colour and material modifications as part of technical progress.

Available finishes and planning information

The lacquers, veneers and solid woods used match the colours seen on the Gwinner living room ranges, dining tables and chairs.

Please note the available finishes in the description of each range as not every coffee table is available in every finish.

The colour and wood finishes have been specifically created for our models and can therefore not be found in any standard. Colour samples provide an approximate reproduction and serve only as a guide.

The coffee table collection can be configured using the Furnplan planning programme:

furnplan

Gwinner coffee tables have been awarded the DGM mark of quality by the German Furniture Quality Association

Country of manufacture: Germany



Home hygiene:

Gwinner coffee tables meet the requirements for a healthy home environment, and have been tested for harmful substances in accordance with RAL-GZ 430/1-1.



Care instructions:

Wipe with a dry duster or a slightly damp cloth. The lacquers are highly resistant to abrasion.

Customer services:

Sales:

You can call us:
Mon to Fri 8 a.m. – 5 p.m. Tel. +49 (0)7445 183 0

Planning information:











You can call us:
Mon to Fri 8 a.m. – 5 p.m. Tel. +49 (0) 7445-183 370
Fax +49 (0) 7445-183 399

Website:

www.gwinner.de

Overview of the Gwinner coffee table collection

Coffee tables with wooden tabletop:

Range	
 <p>CT302</p>	<p>Available in two sizes, with and without step function. For prices, finishes, dimensions and technical details, see the model overview on page 6-7.</p>
 <p>CT303</p>	<p>Available in two sizes, with and without step function. For prices, finishes, dimensions and technical details, see the model overview on page 8-9.</p>
 <p>CT306</p>	<p>Available in three sizes. For prices, finishes, dimensions and technical details, see the model overview on page 10.</p>
 <p>CT103-108 CT104-100</p>	<p>Available in one size. For prices, finishes, dimensions and technical details, see the model overview on page 11.</p>
 <p>CT500 CT501</p>	<p>Available in five sizes. For prices, finishes, dimensions and technical details, see the model overview on page 12-13.</p>
 <p>NEW CT519</p>	<p>Available in one size. For prices, finishes, dimensions and technical details, see the model overview on page 14.</p>
 <p>NEW CT518</p>	<p>Available in four sizes. For prices, finishes, dimensions and technical details, see the model overview on page 15.</p>
 <p>CT510</p>	<p>Available in three sizes, some with or without drawers. For prices, finishes, dimensions and technical details, see the model overview on page 16.</p>
 <p>CT511</p>	<p>Available in three sizes, some with or without drawers. For prices, finishes, dimensions and technical details, see the model overview on page 17.</p>
 <p>NEW CT514 CT515</p>	<p>Available in five sizes. For prices, finishes, dimensions and technical details, see the model overview on page 18.</p>
 <p>NEW CT516 CT517</p>	<p>Available in one size. For prices, finishes, dimensions and technical details, see the model overview on page 19.</p>

Overview of the Gwinner coffee table collection

Coffee tables with wooden tabletop and coffee tables with glass tabletop:

Range	
 CT-F CTV-F	Available in three sizes, with and without lift function. For prices, finishes, dimensions and technical details, see the model overview on page 20 .
 CT507	Available in two sizes, with or without drawers. For prices, finishes, dimensions and technical details, see the model overview on page 21 .
 CT503	Available in three sizes. For prices, finishes, dimensions and technical details, see the model overview on page 22 .
 CT504 CT505	Available in one size. For prices, finishes, dimensions and technical details, see the model overview on page 23 .
 CT101-80	Available in one size. For prices, finishes, dimensions and technical details, see the model overview on page 24 .
 CT102-40	Available in one size. For prices, finishes, dimensions and technical details, see the model overview on page 24 .
 CT403	Available in two sizes. For prices, finishes, dimensions and technical details, see the model overview on page 25 .
 CT404-110 CT405-110	Available in one size, with drawers. For prices, finishes, dimensions and technical details, see the model overview on page 26-27 .
 NEW CT322-110	Available in one size, with and without drawers. For prices, finishes, dimensions and technical details, see the model overview on page 28 .
 NEW CT323-110	Available in one size, with and without drawers. For prices, finishes, dimensions and technical details, see the model overview on page 29 .
 CT409	Available in two sizes. For prices, finishes, dimensions and technical details, see the model overview on page 30 .

Lacquered pedestal and carcass finishes:**Price group 2**

White, fango, cashmere, cream, taupe, anthracite matt silk

Veneered tabletop:

Natural oak timber, honey oak timber, natural wild oak, honey wild oak, natural knotty walnut, natural planked walnut

Veneered pedestal, carcass and top finishes:**Price group 4**

Natural oak timber, honey oak timber, natural wild oak, honey wild oak, natural knotty walnut, natural planked walnut

CT302-85, CT302-110

Fixed design

CT302-85L, CT302-110L

Stepped tabletop



The carcass and tabletop corners are slightly rounded.



LED sensor lighting

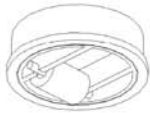

With swivel castors

Not stepped



Stepped tabletop

Usable internal height 8 cm

Tabletops: Thickness 13 mm

Base panel: Stainless steel 25 mm

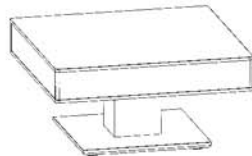

43/85/85 cm

CT302-85

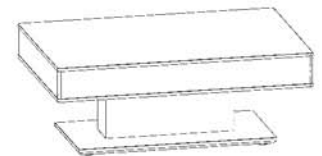

43/110/65 cm

CT302-110

Height/width/depth:

Order no.

PG 2

PG 4

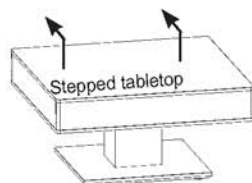

43/(64)/85/85 cm

CT302-85L

Lighting set for stepped table

LED sensor lighting
Inc. battery and charger.
Switches on automatically
when the tabletop is opened.

CTLSET302

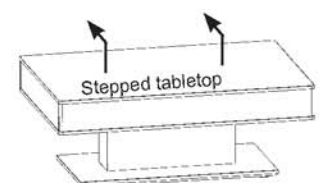

43(64)/110/65 cm

CT302-110L

Height/width/depth:

Order no.

PG 2

PG 4

Lacquered pedestal and carcass finishes:	Price group 1
White, fango, cashmere, cream, taupe, anthracite matt silk	
Veneered tabletop:	
Natural wild core beech	

Lacquered pedestal and carcass finishes:	Price group 2
White, fango, cashmere, cream, taupe, anthracite matt silk	
Veneered or laminate tabletop:	
Natural oak timber, honey oak timber, natural wild oak, honey wild oak, satin natural oak, natural knotty walnut, natural planked walnut Concrete look, rust-effect look	

Veneered pedestal, carcass and top finishes:	Price group 3
Natural wild core beech	

Pedestal finishes, carcass in veneer:	Price group 4
Veneered or laminate tabletop:	
Natural oak timber, honey oak timber, natural wild oak, honey wild oak, satin natural oak, natural knotty walnut, natural planked walnut, concrete look, rust-effect look	

CT303-85, CT303-110

Fixed design

CT303-85L, CT303-110L

Stepped tabletop



Angled carcass and tabletop corners.

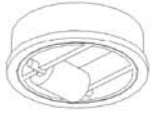

With swivel castors

Not stepped



LED sensor lighting



Stepped tabletop

Usable internal height 8 cm

Tabletops: Thickness 13 mm

Base panel: Stainless steel 25 mm

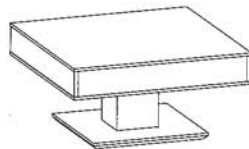

43/85/85 cm

CT303-85

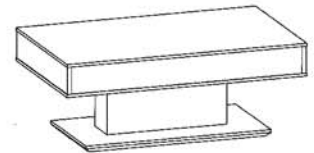

43/110/65 cm

CT303-110

Height/width/depth:

Order no.

PG 1

PG 2

PG 3

PG 4

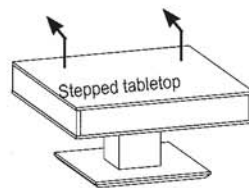

43/(64)/85/85 cm

CT303-85L

Lighting set for stepped table

LED sensor lighting
Inc. battery and charger.
Switches on automatically
when the tabletop is opened.

CTLSET303

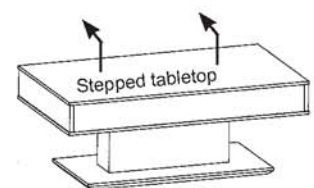

43(64)/110/65 cm

CT303-110L

Height/width/depth:

Order no.

PG 1

PG 2

PG 3

PG 4

CT306 range

Available finishes

All veneer:

Price group 2

Honey oak timber, natural oak timber, natural knotty walnut



Tabletop: Thickness 33 mm

Storage shelf: Parasol grey glass 8 mm

Side panel: Thickness 33 mm

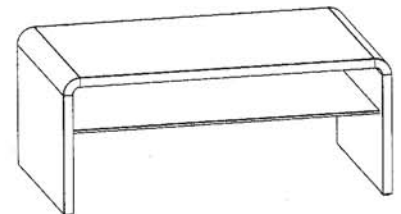
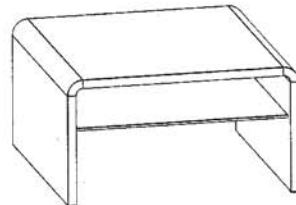
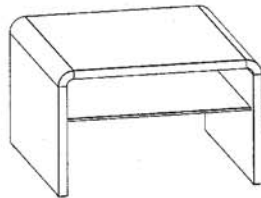

Height/width/depth: 46/74/75 cm

46/84/85 cm

46/109/65 cm

Order no. CT306-75
PG 2

CT306-85

CT306-109

CT103-108

With additional removable tabletop

CT104-100

No functional feature

Veneered tabletop:

Price group 2

Natural oak timber

The additional tabletop can be removed



CT103-108

Tabletop: Thickness 19 mm

Base: Lacquered anthracite



CT104-100

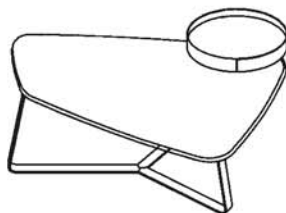

Height/width/depth:

40-53/104/58-66 cm

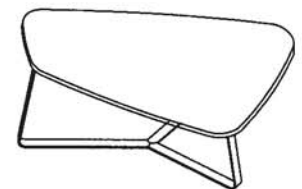

40/100/58 cm

Order no.

CT103-108

CT104-100

PG 2

CT500 range

Available finishes

Laminate storage shelf finishes:	Price group 2
Concrete look, rust-effect look	
Veneered tabletop:	
Honey oak timber, natural oak timber, natural knotty walnut	



Tabletop: Thickness 59 mm
Storage shelf: Thickness 19 mm
Base: Thickness 20 x 20 mm

Base planning information:

The base is delivered in a stainless steel finish as standard.
 It is possible for the base to be lacquered in black at no extra cost, please note this on your order if required.

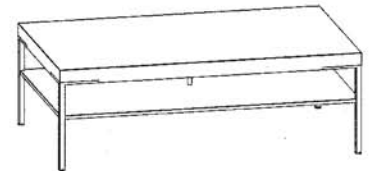
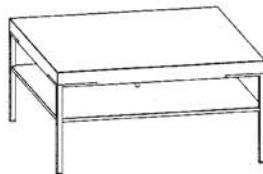
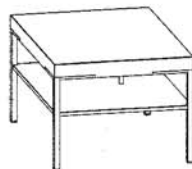

Height/width/depth:	42/65/65 cm	42/75/75 cm	42/85/85 cm	42/110/65 cm	42/125/75 cm
Order no.	CT500-65	CT500-75	CT500-85	CT500-110	CT500-125
PG 2					

When ordering, please specify the finish of the tabletop, storage shelf and base.

CT501 range

Available finishes

Lacquer tabletop and storage shelf finishes:	Price group 1
White, cream, cashmere, fango, taupe, anthracite matt silk	
Lacquer storage shelf finishes:	Price group 2
White, cream, cashmere, fango, taupe, anthracite matt silk	
Veneered or laminate tabletop:	
Natural wild core beech, honey wild oak, natural wild oak, honey oak timber, natural oak timber, satin natural oak, natural planked walnut, natural knotty walnut, concrete look, rust-effect look	
Lacquer storage shelf finishes:	Price group 3
White, cream, cashmere, fango, taupe, anthracite matt silk	
Veneered tabletop:	
Textured terra oak timber	

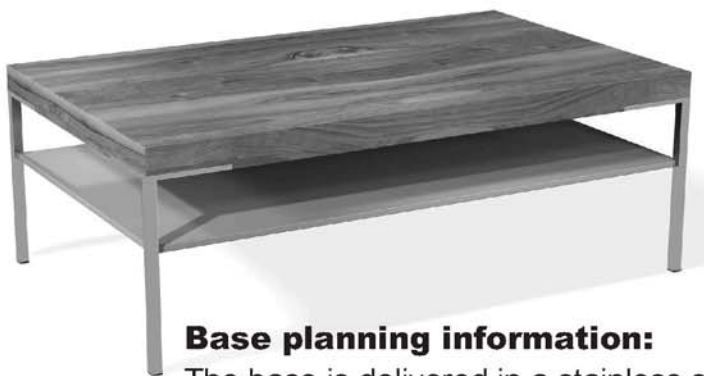

Tabletop: Thickness 59 mm
Storage shelf: Thickness 13 mm
Base: Thickness 20 x 20 mm

Base planning information:

The base is delivered in a stainless steel finish as standard.
 It is possible for the base to be lacquered in black at no extra cost, please note this on your order if required.

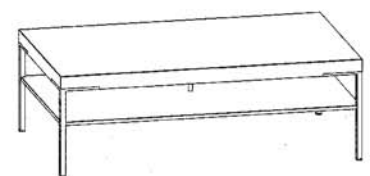
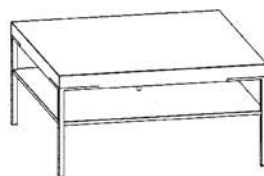
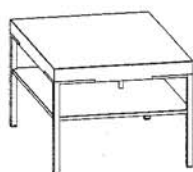

Height/width/depth:	42/65/65 cm	42/75/75 cm	42/85/85 cm	42/110/65 cm	42/125/75 cm
Order no.	CT501-65	CT501-75	CT501-85	CT501-110	CT501-125
	PG 1				
	PG 2				
	PG 3				

When ordering, please specify the finish of the tabletop, storage shelf and base.

Lacquer tabletop and storage shelf finishes:	Price group 1
White, cream, cashmere, fango, taupe, anthracite matt silk	

Lacquer storage shelf finishes:	Price group 2
White, cream, cashmere, fango, taupe, anthracite matt silk	

Tabletop veneered finishes:
Natural wild core beech, honey wild oak, natural wild oak, honey oak timber, natural oak timber, satin natural oak, natural planked walnut, natural knotty walnut

Veneer tabletop and storage shelf finishes:	Price group 3
Natural wild core beech, honey wild oak, natural wild oak, honey oak timber, natural oak timber, satin natural oak, natural planked walnut, natural knotty walnut	

CT519-80 Base in stainless steel

CT521-80 Base in black

Tabletop: Thickness 19 mm
Storage shelf: Thickness 13 mm
Base: Thickness 20 mm

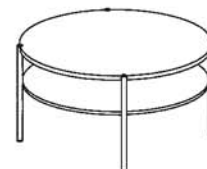
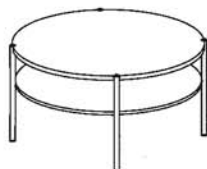

Height/width/depth:

41.6/80/80 cm

41.6/80/80 cm

Order no.

CT519-80

CT521-80

PG 1
 PG 2
 PG 3

When ordering, please specify the finish of the tabletop and storage shelf.

CT518 and CT520 range

CT518-110 Base in stainless steel

CT520-65 Base in black

Tabletop: Thickness 19 mm
Storage shelf: Thickness 13 mm
Base: Thickness 20 mm



CT518 range Base in stainless steel

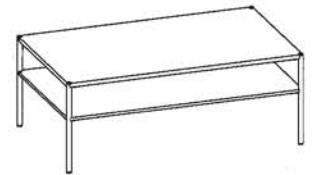

Height/width/depth:

41.6/65/65 cm

41.6/75/75 cm

41.6/85/85 cm

41.6/110/65 cm

Order no.

CT518-65

CT518-75

CT518-85

CT518-110

PG 1
 PG 2
 PG 3

CT520 range Base in black

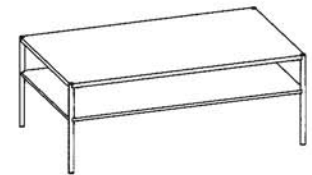
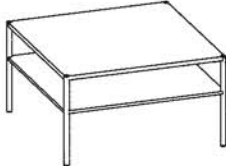

Height/width/depth:

41.6/65/65 cm

41.6/75/75 cm

41.6/85/85 cm

41.6/110/65 cm

Order no.

CT520-65

CT520-75

CT520-85

CT520-110

PG 1
 PG 2
 PG 3

When ordering, please specify the finish of the tabletop and storage shelf.

CT510 range

Available finishes

Lacquer tabletop finishes:	Price group 1
White, fango, anthracite matt silk	
Contrasting strip finishes in lacquer or veneer:	
White, fango, anthracite matt silk Natural wild core beech, honey wild oak, natural wild oak, satin natural oak, natural planked walnut.	

Veneer tabletop finishes:	Price group 2
Natural wild core beech, honey wild oak, natural wild oak, honey oak timber, natural oak timber, satin natural oak, natural planked walnut, natural knotty walnut	
Contrasting strip finishes in lacquer:	
White, fango, anthracite matt silk	

Figure CT510-110



Tabletop: Thickness 25 mm
Base: Thickness 35 x 10 mm

Figure CT510-110

with drawer (optional extra), interior dimensions:
width 54 cm, depth 32 cm, height 6 cm



Drawer surcharge for CT510-110
CT510-SK

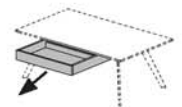

Drawer planning information:

The drawer is only available for the **CT510-110** in white, fango or anthracite matt silk lacquer.

Base planning information:

The base is available in black or stainless steel, please specify which finish is required on your order.



Height/width/depth: 41.3/75/75 cm

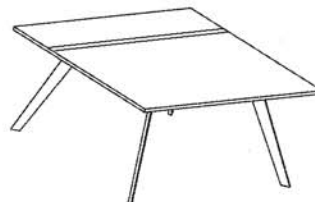

41.3/85/85 cm



41.3/110/65 cm

Order no.

CT510-75

CT510-85

CT510-110

PG 1
PG 2

When ordering, please specify the finish of the tabletop, base and drawer if required.

CT511 range

Available finishes

Lacquer tabletop finishes:

Price group 1

White, fango, anthracite matt silk

Veneer tabletop finishes:

Price group 2

Natural wild core beech, honey wild oak, natural wild oak, honey oak timber, natural oak timber, satin natural oak, natural planked walnut, natural knotty walnut

Figure CT511-110



Tabletop: Thickness 25 mm

Base: Thickness 35 x 10 mm

Figure CT511-110

with drawer (optional extra), interior dimensions: width 54 cm, depth 32 cm, height 6 cm



Drawer surcharge for CT511-110

CT511-SK

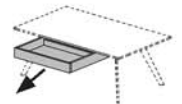

Drawer planning information:

The drawer is only available for the **CT511-110** in white, fango or anthracite matt silk lacquer.

Base planning information:

The base is available in black or stainless steel, please specify which finish is required on your order.



Height/width/depth: 41.3/75/75 cm

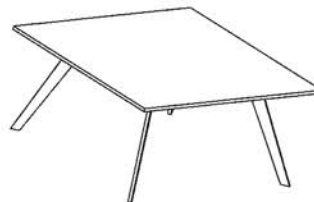

41.3/85/85 cm



41.3/110/65 cm

Order no.

CT511-75

CT511-85

CT511-110

PG 1

PG 2

When ordering, please specify the finish of the tabletop, base and drawer if required.

CT514 and CT515 range

Available finishes

Lacquer finishes:

Price group 1

White, cream, cashmere, fango, taupe, anthracite matt silk

Veneered finishes:

Price group 2

Natural wild core beech, honey wild oak, natural wild oak, honey oak timber, natural oak timber, satin natural oak, natural planked walnut, natural knotty walnut

Figure CT514-108



Figure CT514-108
with glass shelf (optional extra)

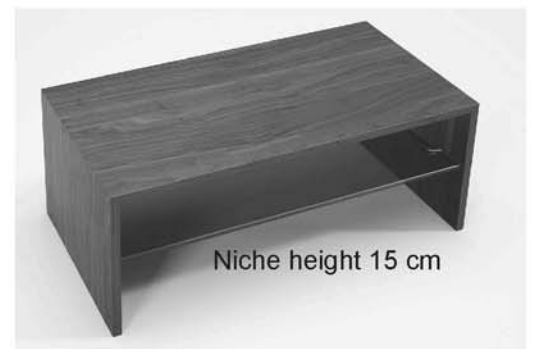

Material thickness: 25 mm

Glass shelves: Thickness 8 mm

Glass shelf surcharge for all 3 widths

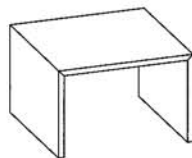

Height/width/depth: 42/65/65 cm

Order no.

CT514-65

PG 1

PG 2

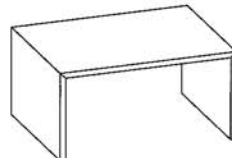

42/85/65 cm

CT514-85

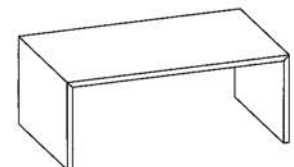

42/107,4/65 cm

CT514-108

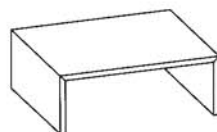

Height/width/depth: 28/85/65 cm

Order no.

CT515-85

PG 1

PG 2

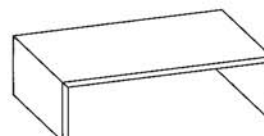

28/100/65 cm

CT515-100

Veneered tabletop:	Price group 1
Grained oak	

CT517 shown with base in black



Not shown CT516, structurally identical but with base in stainless steel.

Tabletop: Thickness 20 mm

Planning information:

Due to the elaborate grained veneer, each coffee table is a truly unique piece, whereby the shape and structure may deviate slightly from that shown in brochure illustrations and display items.

Base in stainless steel

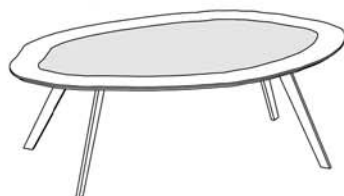

Height/width/depth: 42/approx. 123/approx. 72 cm

Order no. CT516
PG 1

Base in black

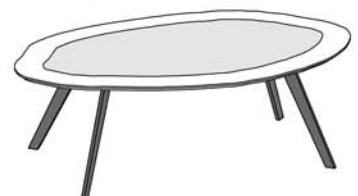

42/approx. 123/approx. 72 cm

CT517

CT-F and CTV-F ranges

Available finishes

Lacquer base and tabletop finishes:	Price group 1
White, cream, cashmere, fango, taupe, anthracite matt silk	

Lacquer base finishes:	Price group 2
White, cream, cashmere, fango, taupe, anthracite matt silk	
Veneered tabletop:	
Natural wild core beech, honey wild oak, natural wild oak, honey oak timber, natural oak timber, satin natural oak, natural planked walnut, natural knotty walnut	



Without height adjustment



With swivel castors



With height adjustment
(infinitely adjustable)

Tabletop: Thickness 19 mm
Plinth panel: Thickness 25 mm

Without height adjustment

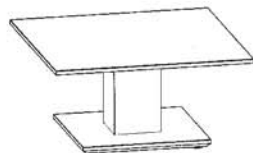

42/85/85 cm

Order no.
CT85F

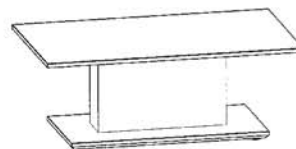

42/110/65 cm

Order no.
CT110F

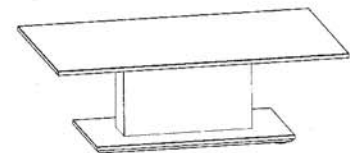

42/125/75 cm

Order no.
CT125F

Height/width/depth:

Order no.

PG 1

PG 2

With height adjustment

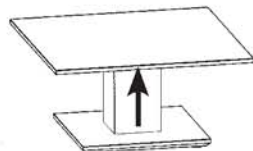

46-65/85/85 cm

Order no.
CTV85F

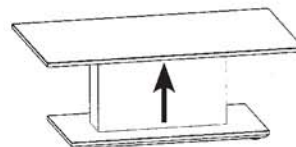

46-65/110/65 cm

Order no.
CTV110F

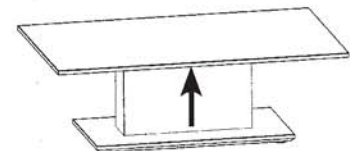

46-65/125/75 cm

Order no.
CTV125F

Height/width/depth:

Order no.

PG 1

PG 2

When ordering, please specify the finish of the base and tabletop.

End panel finishes in lacquer:	Price group 1
White, cream, cashmere, fango, taupe, anthracite matt silk	
Veneered tabletop:	
Honey wild oak, natural wild oak, honey oak timber, natural oak timber, satin natural oak, natural planked walnut, natural knotty walnut	

Base: Stainless steel or anthracite.

Please specify on the order.



Tabletop: Thickness 19 mm

Coffee table without drawer

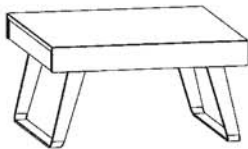

Height/width/depth: 45/85/85 cm

Order no. CT507-85
PG 1

Coffee table with drawer

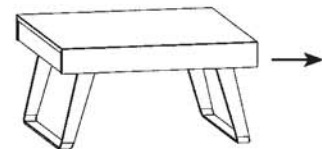

45/85/85 cm

CT507-85A

Coffee table without drawer



Height/width/depth: 45/125/75 cm

Order no. CT507-125
PG 1

Coffee table with drawer

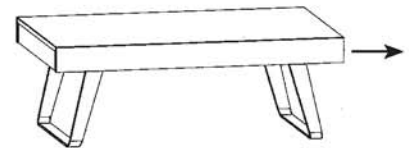

45/125/75 cm

CT507-125A

When ordering, please specify the finish of the end panel and base.

CT503 range

Available finishes

Stainless steel base finish, parasol grey storage shelf Price group 1

Veneered tabletop:

Natural wild core beech

Stainless steel base finish, parasol grey storage shelf Price group 2

Veneered tabletop:

Natural oak timber, honey oak timber, natural knotty walnut



Tabletop: Thickness 19 mm

Storage shelf: Parasol grey glass 8 mm

Base: Stainless steel finish 50 x 8 mm

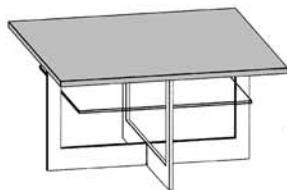

45/85/85 cm

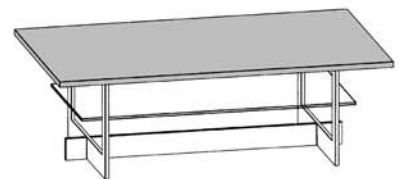

40/110/65 cm

40/125/75 cm

Height/width/depth:

Order no.

PG 1

PG 2

CT503-85

CT503-110

CT503-125

CT504 and CT505 range

Available finishes

Stainless steel base finish, parasol grey storage shelf Price group 1

Veneered tabletop:

Natural wild core beech

Stainless steel base finish, parasol grey storage shelf Price group 2

Veneered tabletop:

Natural oak timber, honey oak timber, natural knotty walnut



Tabletop: Thickness 19 mm

Storage shelf: Parasol grey glass 8 mm

Base: Stainless steel finish 50 x 8 mm



45/85/85 cm

Order no. CT504-85



53/55/55 cm

Order no. CT505-55

Order no.
PG 1
PG 2

CT101-80

CT102-40

Veneered tabletop: Price group 2

Natural oak timber

CT101-80

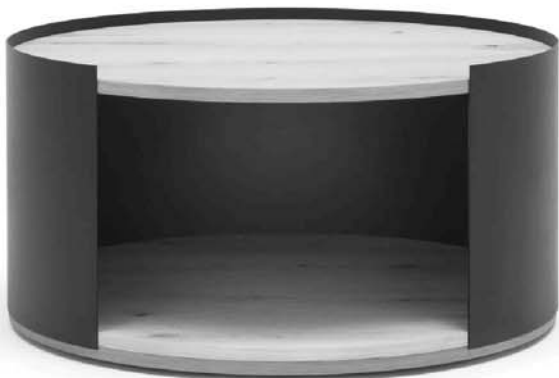

With swivel castors

Tabletop: Thickness 19 mm
Plinth panel: Thickness 38 mm
Base: Lacquered anthracite

CT102-40

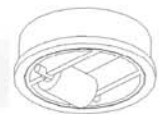

With swivel castors

Tabletop: Thickness 19 mm
Plinth panel: Thickness 38 mm
Glass shelf: Thickness 6 mm
Base: Lacquered anthracite

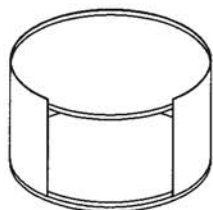

Height/width/depth: 41/80/80 cm

Order no. CT101-80
PG 2

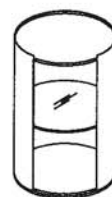

56/40/40 cm

CT102-40

CT403 range

Available finishes

Lacquer pedestal finishes:

Price group 1

White, cream, fango, taupe, anthracite matt silk lacquer

Veneered pedestal finishes:

Price group 4

Natural wild core beech, honey oak timber, honey wild oak, natural oak timber, natural knotty walnut, natural planked walnut

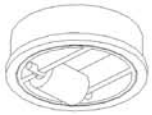
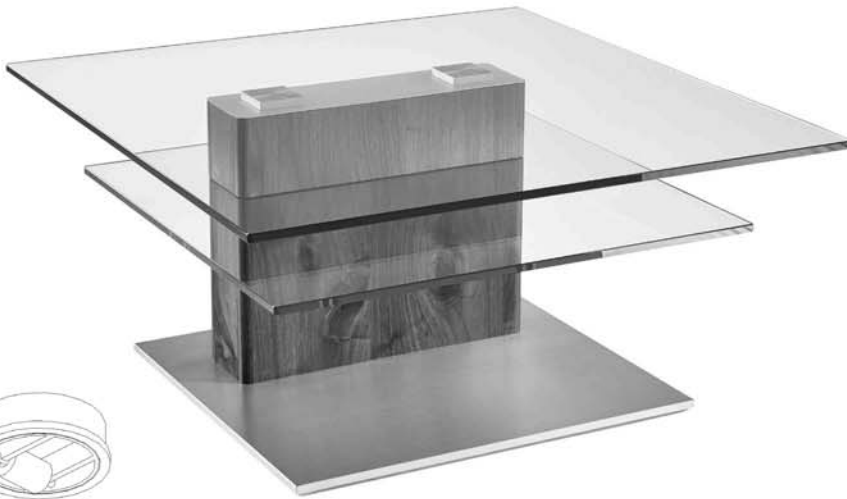

With swivel castors

Tabletops: Clear glass, thickness 12 mm

Base panel: Stainless steel 25 mm

Pedestal: Lacquer or veneer 450 x 120 mm

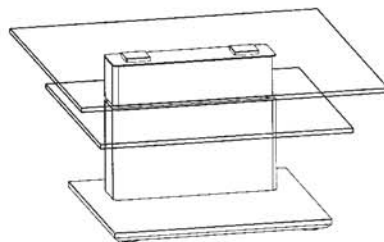

43/85/85 cm

CT403-85

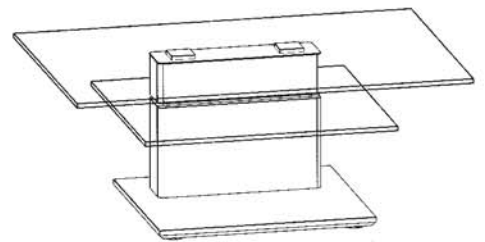

43/110/75 cm

CT403-110

Height/width/depth:

Order no.

PG 1

PG 4

Lacquer supporting section and base plate finishes: Price group 2

White, cream, cashmere, fango, taupe, anthracite matt silk

Veneered or laminate drawers:

Natural wild core beech, honey wild oak, natural wild oak, honey oak timber, natural oak timber, satin natural oak, natural planked walnut, natural knotty walnut.
Concrete look, rust-effect look, nero marble effect

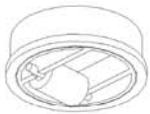
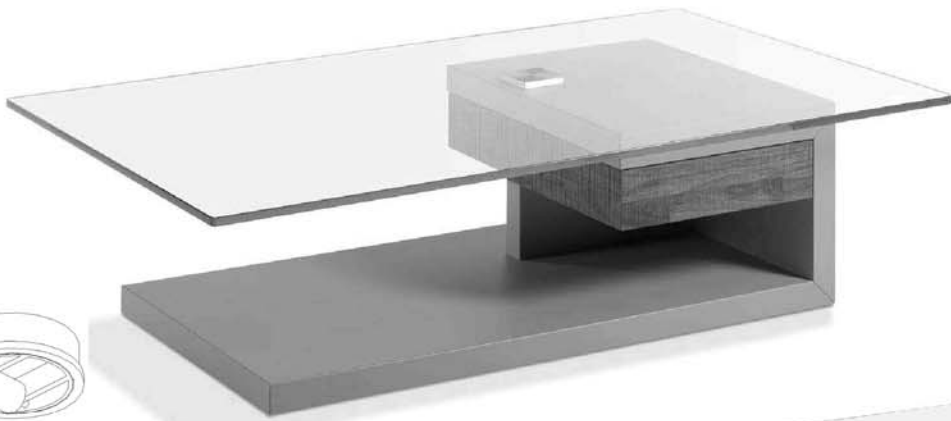

With swivel castors

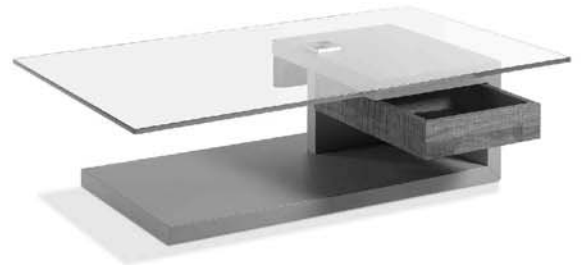

Tabletop: Clear glass, thickness 12 mm

Supporting section (base):

Thickness 38 mm

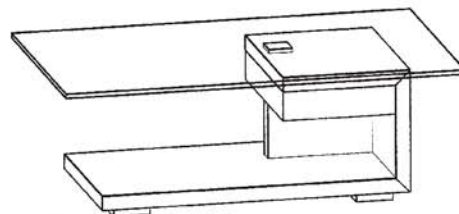

Height/width/depth:

40/110/65 cm

Order no.

CT404-110

PG 2

When ordering, please specify the finish of the supporting section and drawer.

Veneered supporting section and base plate finishes: Price group 2

Natural wild core beech, honey wild oak, natural wild oak, honey oak timber, natural oak timber, satin natural oak, natural planked walnut, natural knotty walnut

Matt silk lacquer or laminate drawers:

White, cream, cashmere, fango, taupe, anthracite matt silk.
Concrete look, rust-effect look, nero marble effect

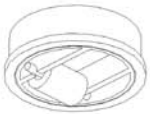
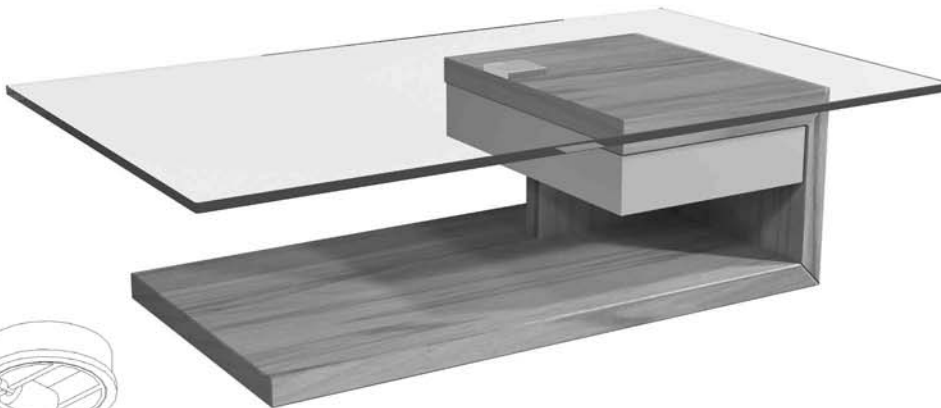

With swivel castors



Tabletop: Clear glass, thickness 12 mm

Supporting section (base):

Thickness 38 mm

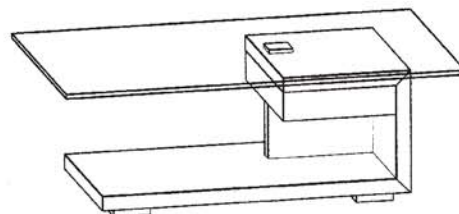

Height/width/depth:

40/110/65 cm

Order no.
PG 2

CT405-110

When ordering, please specify the finish of the supporting section and drawer.

CT322 range

Available finishes

Lacquer interior section finishes:	Price group 1
White, cream, cashmere, fango, taupe, anthracite matt silk	
Veneer supporting section finishes:	
Natural wild core beech, honey wild oak, natural wild oak, honey oak timber, natural oak timber, satin natural oak, natural planked walnut, natural knotty walnut	

CT322-110L shown



With swivel castors

Supporting section: Thickness 25 mm
Continuous veneer grain

Drawer planning information:

The **CT322-SK** drawer is always the same lacquer colour as the interior section.

CT322-110L shown

with drawer (optional extra), interior dimensions:
width 67 cm, depth 39 cm, height 8 cm

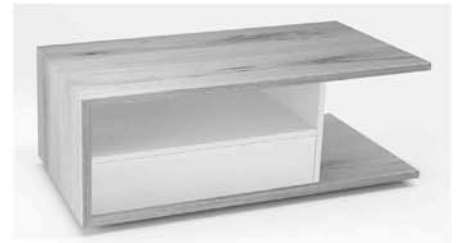

Drawer surcharge for CT322

CT322-SK

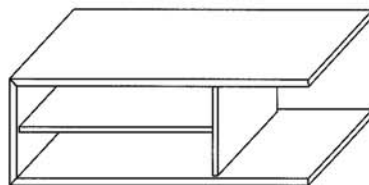
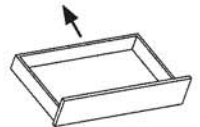

Height/width/depth: 43/110/65 cm

Order no. CT322-110L
PG 1

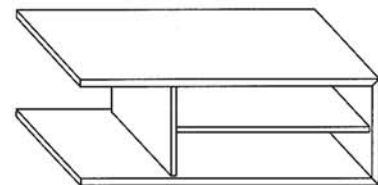

43/110/65 cm

CT322-110R

When ordering, please specify that finish of the supporting section, interior section and the drawer, if required.

CT323 range

Available finishes

Lacquer interior section finishes:

Price group 1

White, cream, cashmere, fango, taupe, anthracite matt silk

Veneer supporting section finishes:

Natural wild core beech, honey wild oak, natural wild oak, honey oak timber, natural oak timber, satin natural oak, natural planked walnut, natural knotty walnut

CT322-110L shown

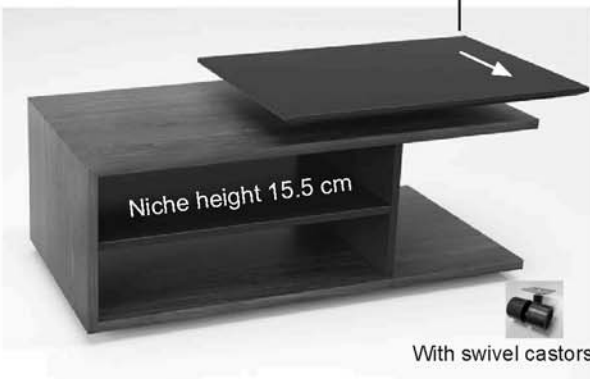

The storage shelf is height-adjustable and extendable towards the front.

With swivel castors

Supporting section: Thickness 25 mm
Continuous veneer grain

Planning information for drawers and the storage shelf:

The **CT323-SK** drawer is always the same lacquer colour as the interior section. The storage shelf is delivered in the same lacquer colour as the interior section as standard; it can, however, be delivered in veneer for a surcharge. If required, please clearly state this on your order.

CT322-110L shown

with drawer (optional extra), interior dimensions: width 67 cm, depth 39 cm, height 8 cm

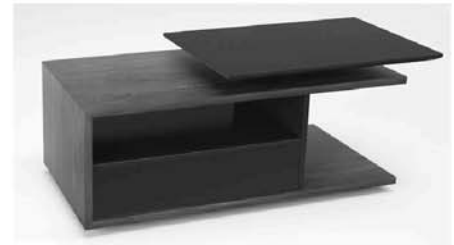

Drawer surcharge for CT323

CT323-SK

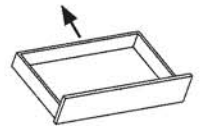

Veneer storage shelf surcharge
CT323ABF

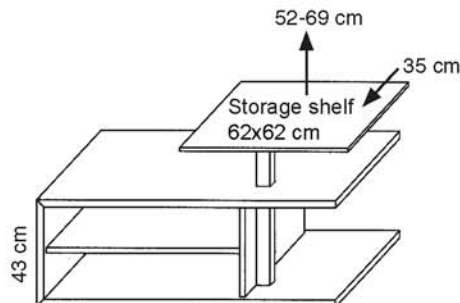

Height/width/depth: 43-69/110/65 cm

Order no. CT323-110L
PG 1

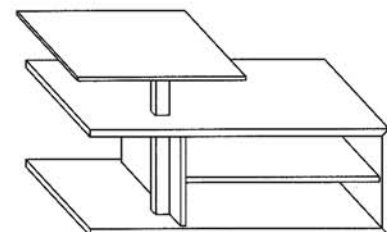

43-69/110/65 cm

CT323-110R

When ordering, please specify that finish of the supporting section, interior section and the drawer, if required.

Lacquer pedestal finishes:	Price group 1
White, fango, anthracite matt silk	
Pedestal contrasting surface in solid wood or veneer:	
Natural brushed and oiled solid wild oak, veneered textured terra oak timber	

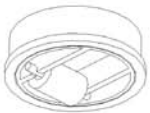

With swivel castors

Tabletop: Parasol grey glass thickness 12 mm

Storage shelf: Parasol grey glass (thickness 8 mm), size 600 x 320 mm

Base panel: Stainless steel 25 mm

Pedestal: Lacquer 450 x 120 mm

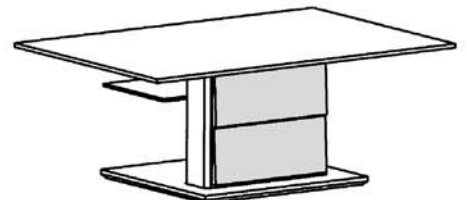
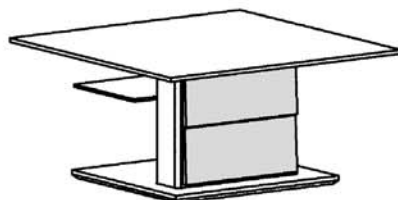

Height/width/depth: 43/85/85 cm

43/110/70 cm

Order no. CT409-85
PG 1

CT409-110

GWINNER[®]